



# LED Back-Up Lamp Series 816

( Aftermarket electronic equipment in vehicles )

## Installation Manual

PN : 816XLFM

### Component parts

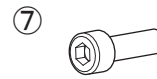
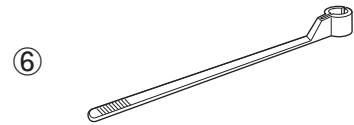
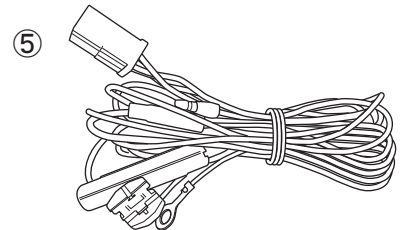
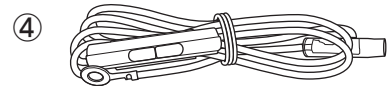
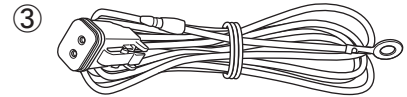
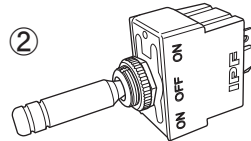
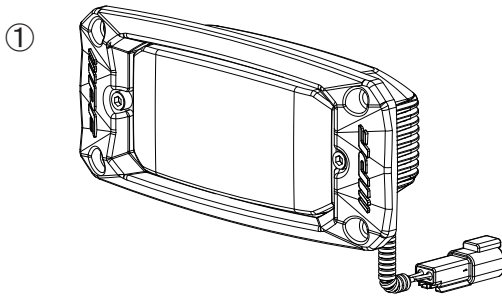

No.	Lamp and kit parts	No. of pcs
①	Lamp	1
②	Switch	1
③	Harness A	1
④	Harness B	1
⑤	Harness C	1
⑥	Cable tie	5
⑦	Cap bolts (M5 x 16)	4
⑧	Flange nuts (M5)	4

## How to install



Loose clamping condition may cause the lamp to come off.



Secure each bolt, nut and screw tightly. Check to fix attached location regularly.

1. Choose a location for your IPF flush mount lamp. Check to see if you have clearance for the lamp to install/adjust without interference.

Make holes according to the sizes in the image below.

### ⚠ Caution

Aim optical axis downward below the centerline of the lamp.  
Install the lamp on vertical mounting surface or downward-facing surface.

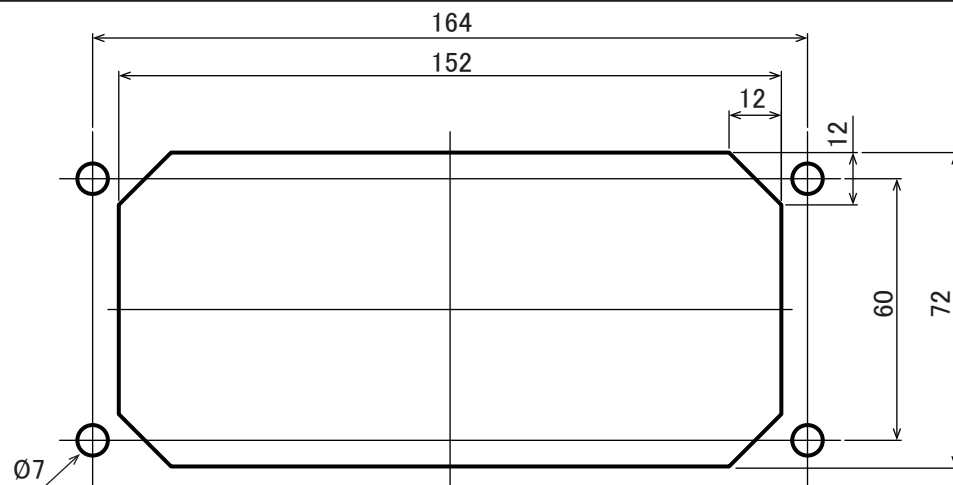

UNIT:mm

2. Secure the lamp with the cap bolts and the flange nuts provided.

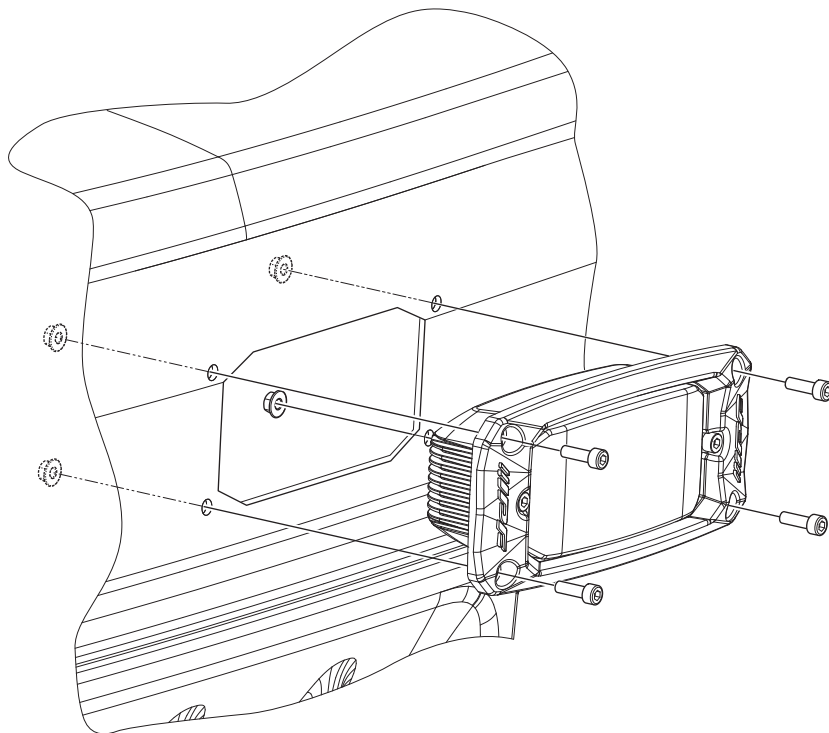

## Specification

PN	Power consumption	Operating voltage	Operating temperature	Weight
816XLFM	12V/12.7W	9V~36V	-30°C~+50°C	540g
	24V/12.4W			

# How to wire



Before the installation work, you must remove the (-) terminal of the battery.  
If the vehicle mounts 2 batteries, remove both (-) terminals.



Install the relay and harness in a position where it will not make contact with high temperature surface. (Such as engine, radiators, or supercharger, exhaust pipes.)



All the connectors and terminals should be solidly connected.



Do not pull strongly the harness and connectors.



Install the harness and cords in a position where it will not be scratched, bent or pressed such as in moving parts (Pedals / Wires / Doors / Belts / Pulleys). In some cases, it may cause the vehicle to catch fire.



Harness and cords should be securely tied by cable ties or tapes.

**Caution**  
Consumption current are 1.1A when operated by 12v vehicles and 0.5A by 24v vehicles.  
Use the bigger fuse if total consumption current exceeds your fuse capacity.

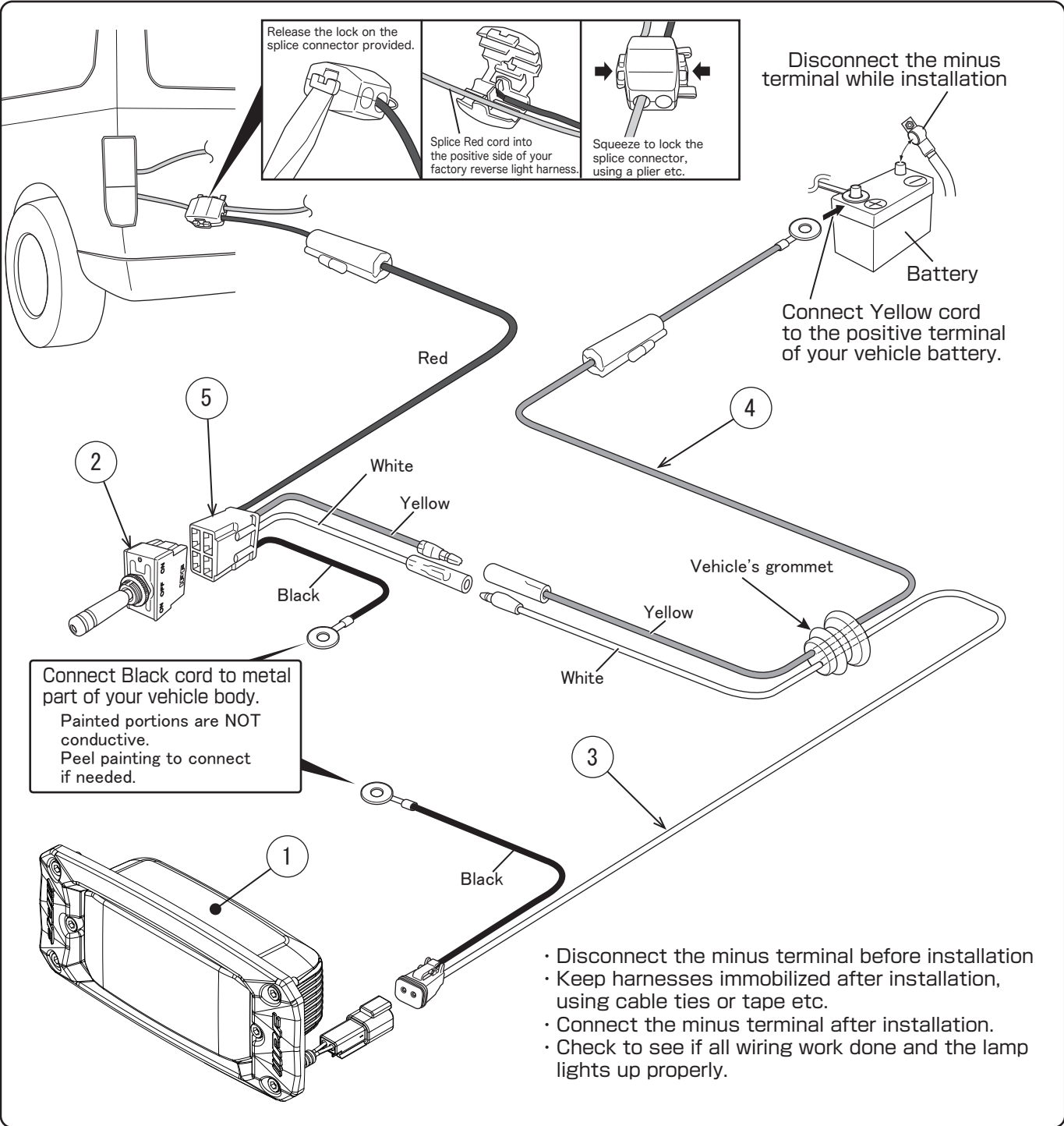

## How to install switch

1. Make a 12mm-diameter hole in desired location, switch hole cover etc.  
Insert the switch into the hole prepared from backside.  
Hold on the switch from the front side using the face nut.

2. Set "ON" to the upper side. See the image below.

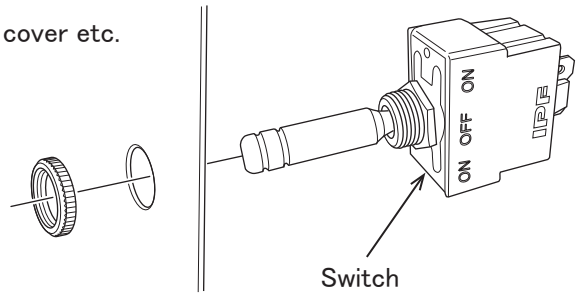
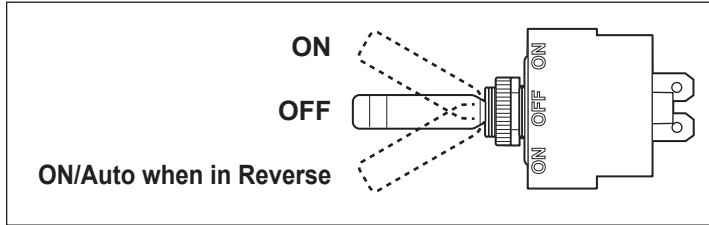

Remove the face nut from the switch and attach it from the front side.  
See the image above.

# TEMPLATE

PN : 816XLFM

